

FM751V-FL

List

List..... 1

Package outline..... 2

Features..... 2

Mechanical data..... 2

Maximum ratings 2

Rating and characteristic curves..... 3

Pinning information..... 4

Marking..... 4

Suggested solder pad layout..... 4

Packing information..... 5

Reel packing..... 6

Suggested thermal profiles for soldering processes..... 6

High reliability test capabilities..... 7

FM751V-FL

30mA Surface Mount Small Signal Schottky Diode- 40V

Package outline

Features

- Low Forward Voltage Drop
- Flat Lead SOD-323FL Small Outline Plastic Package
- Surface Device Type Mounting
- Lead-free parts for green partner, exceeds environmental standards of MIL-STD-19500 /228
- Suffix "-H" for Halogen-free part, ex. FM751V-FL-H.

Mechanical data

- Epoxy:UL94-VO rated flame retardant
- Case : Molded plastic, SOD-323FL
- Terminals : Solder plated, solderable per MIL-STD-750, Method 2026
- Polarity : Indicated by cathode band
- Mounting Position : Any
- Weight : Approximated 0.004 gram

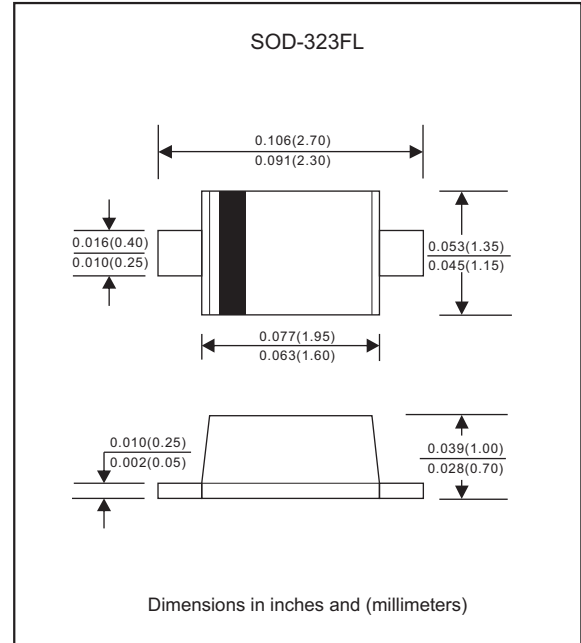

Maximum ratings (AT T_A=25°C unless otherwise noted)

PARAMETER	CONDITIONS	Symbol	Value	UNIT
Power Dissipation		P _D	200	mW
Repetitive Peak Reverse Voltage		V _{RRM}	40	V
Reverse Voltage		V _R	30	V
Forward Current		I _F	30	mA
Non-Repetitive Peak Forward Current	60Hz for 1cycle	I _{FSM}	500	mA
Operating Junction Temperature		T _J	+125	°C
Storage Temperature Range		T _{STG}	-55~+125	°C

These ratings are limiting values above which the serviceability of the diode may be impaired.

Electrical Characteristics (AT T_A=25°C unless otherwise noted)

PARAMETER	CONDITIONS	Symbol	MIN.	TYP.	MAX.	UNIT
Breakdown Voltage	I _R = 10uA	V _{BR}	30			V
Forward voltage	I _F = 1.0 mA	V _F			0.37	V
Reverse current	V _R = 30 V	I _R			0.5	uA
Diode capacitance	V _R = 1 V, f = 1MHz	C _T		2.0		pF

Rating and characteristic curves (FM751V-FL)

FIG.1-TYPICAL FORWARD CHARACTERISTICS

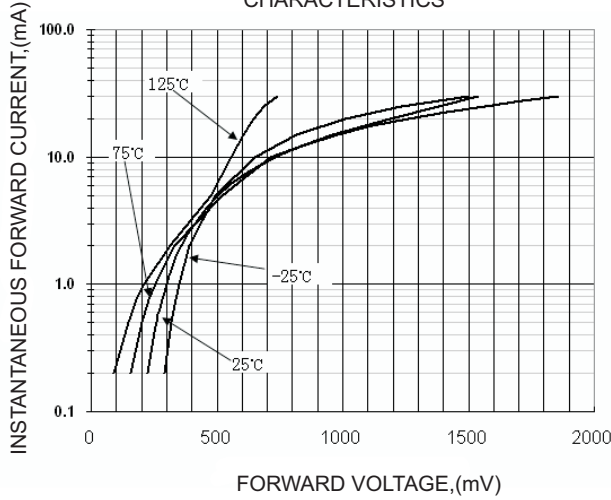

FIG.2 - TYPICAL REVERSE CHARACTERISTICS

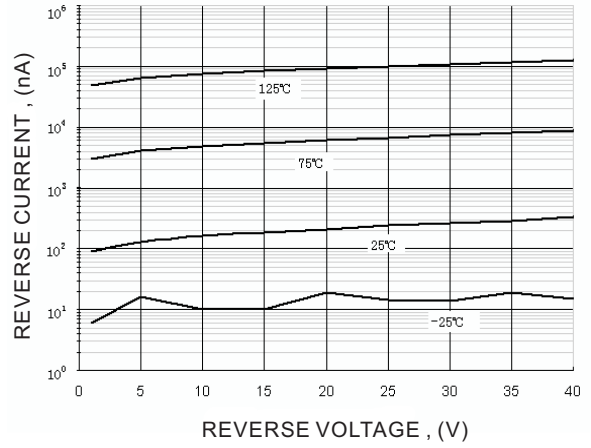
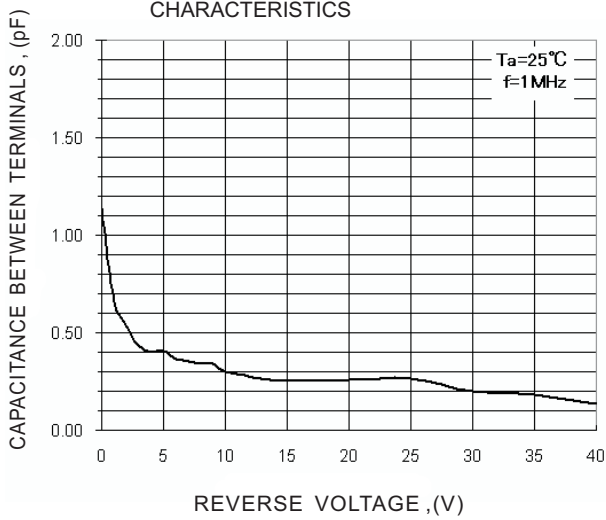



FIG.3-CAPACITANCE BETWEEN TERMINALS CHARACTERISTICS



FM751V-FL

Pinning information

Pin	Simplified outline	Symbol
Pin1 cathode Pin2 anode		

Marking

Type number	Marking code
FM751V-FL	B5

Suggested solder pad layout

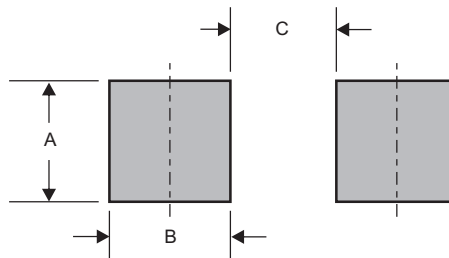

Dimensions in inches and (millimeters)

PACKAGE	A	B	C
SOD-323FL	0.032 (0.82)	0.022 (0.56)	0.069 (1.75)

FM751V-FL

Packing information

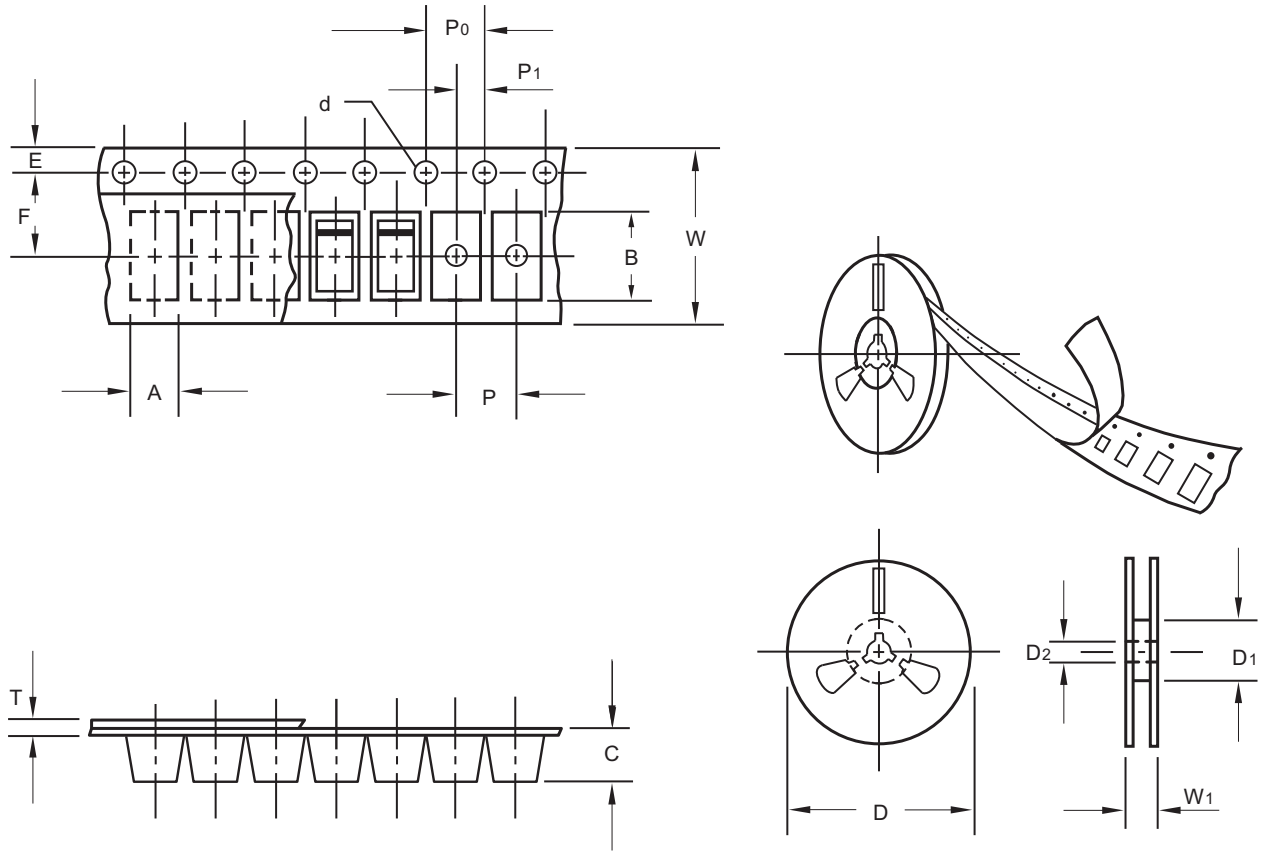

unit:mm

Item	Symbol	Tolerance	SOD-323FL
Carrier width	A	0.1	1.46
Carrier length	B	0.1	2.95
Carrier depth	C	0.1	1.25
Sprocket hole	d	0.1	1.50
13" Reel outside diameter	D	2.0	-
13" Reel inner diameter	D1	min	-
7" Reel outside diameter	D	2.0	178.00
7" Reel inner diameter	D1	min	62.00
Feed hole diameter	D2	0.5	13.00
Sprocket hole position	E	0.1	1.75
Punch hole position	F	0.1	3.50
Punch hole pitch	P	0.1	4.00
Sprocket hole pitch	P0	0.1	4.00
Embossment center	P1	0.1	2.00
Overall tape thickness	T	0.1	0.23
Tape width	W	0.3	8.00
Reel width	W1	1.0	11.40

Note: Devices are packed in accordance with EIA standard RS-481-A and specifications listed above.

FM751V-FL

Reel packing

PACKAGE	REEL SIZE	REEL (pcs)	COMPONENT SPACING (m/m)	BOX (pcs)	INNER BOX (m/m)	REEL DIA, (m/m)	CARTON SIZE (m/m)	CARTON (pcs)	APPROX. GROSS WEIGHT (kg)
SOD-323FL	7"	3,000	4.0	30,000	183*183*123	178	382*262*387	240,000	9.5

Suggested thermal profiles for soldering processes

- 1.Storage environment: Temperature=5°C~40°C Humidity=55%±25%
- 2.Reflow soldering of surface-mount devices

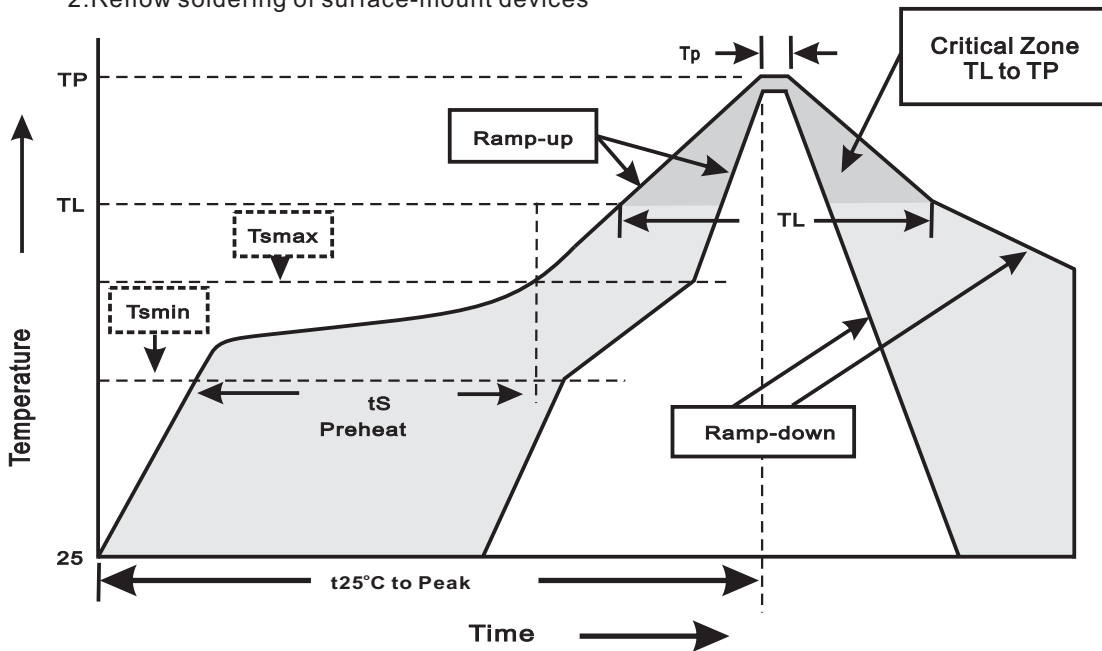

3.Reflow soldering

Profile Feature	Soldering Condition
Average ramp-up rate(T _L to T _P)	<3°C/sec
Preheat -Temperature Min(T _{min}) -Temperature Max(T _{max}) -Time(min to max)(t _s)	150°C 200°C 60~120sec
T _{max} to T _L -Ramp-upRate	<3°C/sec
Time maintained above: -Temperature(T _L) -Time(t _L)	217°C 60~260sec
Peak Temperature(T _P)	255°C-0/+5°C
Time within 5°C of actual Peak Temperature(t _P)	10~30sec
Ramp-down Rate	<6°C/sec
Time 25°C to Peak Temperature	<6minutes

FM751V-FL**High reliability test capabilities**

Item Test	Conditions	Reference
1. Solder Resistance	at $260\pm 5^{\circ}\text{C}$ for $10\pm 2\text{sec.}$ immerse body into solder $1/16''\pm 1/32''$	MIL-STD-750D METHOD-2031
2. Solderability	at $245\pm 5^{\circ}\text{C}$ for 5 sec.	MIL-STD-202F METHOD-208
3. High Temperature Reverse Bias	$V_R=80\%$ rate at $T_J=125^{\circ}\text{C}$ for 168 hrs.	MIL-STD-750D METHOD-1038
4. Forward Operation Life	Rated average rectifier current at $T_A=25^{\circ}\text{C}$ for 500hrs.	MIL-STD-750D METHOD-1027
5. Intermittent Operation Life	$T_A = 25^{\circ}\text{C}$, $I_F = I_O$ On state: power on for 5 min. off state: power off for 5 min. on and off for 500 cycles.	MIL-STD-750D METHOD-1036
6. Pressure Cooker	$15P_{SIG}$ at $T_A=121^{\circ}\text{C}$ for 4 hrs.	JESD22-A102
7. Temperature Cycling	-55°C to $+125^{\circ}\text{C}$ dwelled for 30 min. and transferred for 5min. total 10 cycles.	MIL-STD-750D METHOD-1051
8. Thermal Shock	0°C for 5 min. rise to 100°C for 5 min. total 10 cycles.	MIL-STD-750D METHOD-1056
9. Forward Surge	60Hz for 1cycle	MIL-STD-750D METHOD-4066-2
10. Humidity	at $T_A=85^{\circ}\text{C}$, RH=85% for 1000hrs.	MIL-STD-750D METHOD-1021
11. High Temperature Storage Life	at 175°C for 1000 hrs.	MIL-STD-750D METHOD-1031